

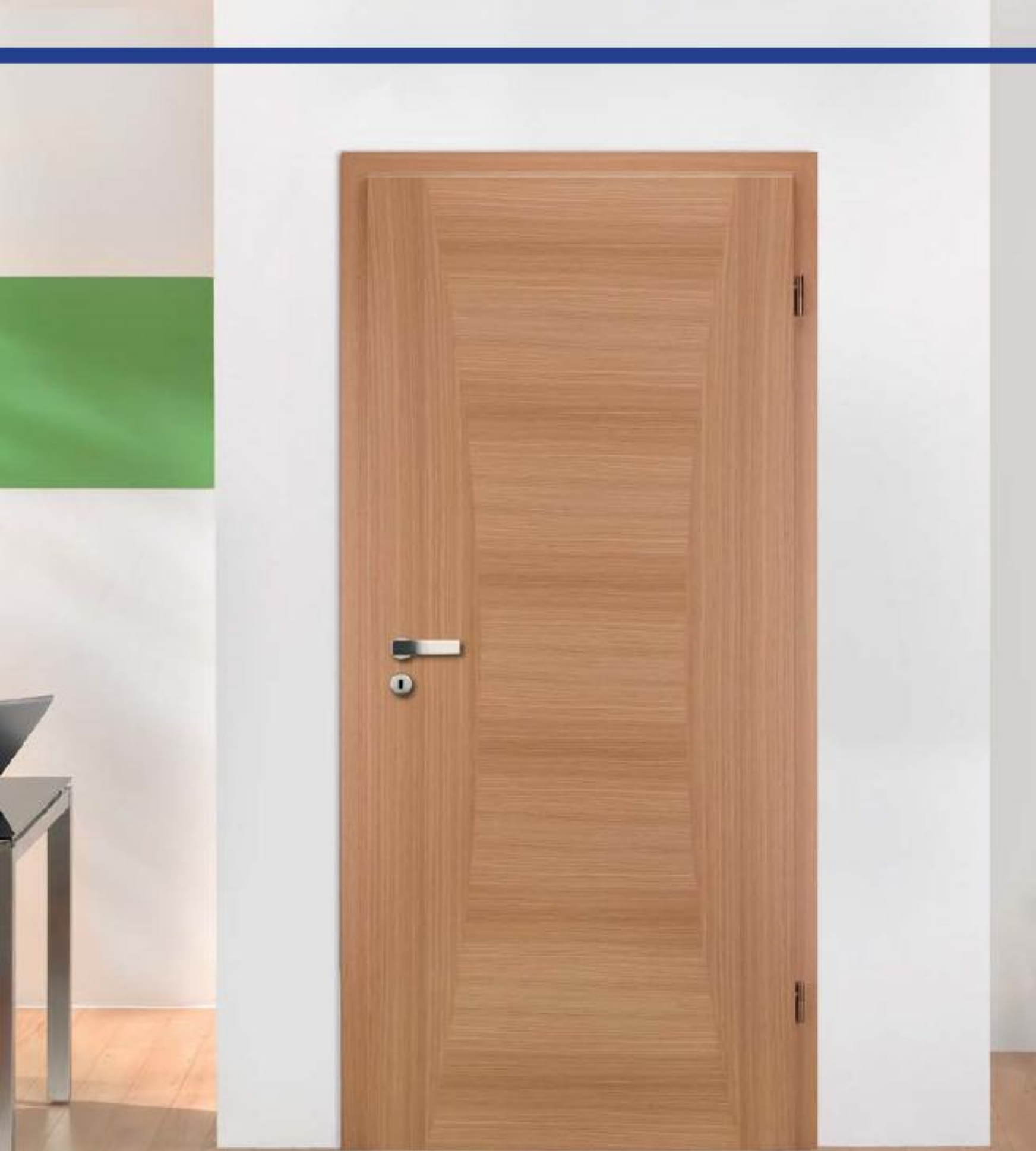

AURA 210
Weißeiche Natur
Glas-Design 6.3
Glasleiste in Metalloptik





AURA 120, Weißbeiche Natur



AURA 110, Weißbeiche Natur



AURA 220 Ahorn, Glas-Design 9.2



AURA 110 Ahorn





AURA 210 Ahorn
Glas-Design 9.2



AURA 310 Ahorn
Glas-Design 6.4



AURA 311 Ahorn
Glas-Design 16.1 rot



AURA 312 Ahorn
Glas-Design 16.1 blau



AURA 330 Ahorn
Glas-Design 18.2



AURA 630 Ahorn
Glas-Design 6.4



AURA 530 Ahorn
Glas-Design 17.3 orange



AURA 731 Ahorn



AURA 730 Ahorn



AURA 710 Ahorn



AURA 732 Ahorn





AURA 410, Weißlack,
Normzarge mit profilierter 75er Bekleidung



AURA 310, Weißlack, Verglasung 7.2
Normzarge mit eckiger 55er Bekleidung





AURA 140 Buche



AURA 230 Buche, Verglasung Gothik weiß
Normzarge mit bombierter 75er Bekleidung



AURA 110 Buche



AURA 730 Buche





AURA Ganzglas, Design 6.3

AURA 310 Nussbaum Glas-Design 6.3



AURA 410, Nussbaum





AURA 210, Drehtür 2-flg., Nussbaum,
mit Glasleisten in Edelstahloptik
Glas-Design 18.1



AURA 130, Nussbaum



AURA 310, Nussbaum, Glas-Design 20.2



Leicht & schnell



AURA Glas-Design 8.2



AURA Glas-Design 18-0



AURA Glas-Design 17-3 rot



AURA Glas-Design 6-3



AURA Glas-Design 18-0 S



AURA Glas-Design 17-3 blau



AURA Glas-Design 6-4 S



AURA Glas-Design 16-0 rot



AURA Glas-Design 15-2 rot



AURA Glas-Design 15-0 rot



AURA Glas-Design 16-1 S blau



AURA Glas-Design 15-0 orange



AURA Glas-Design 16-1 orange



GG M01

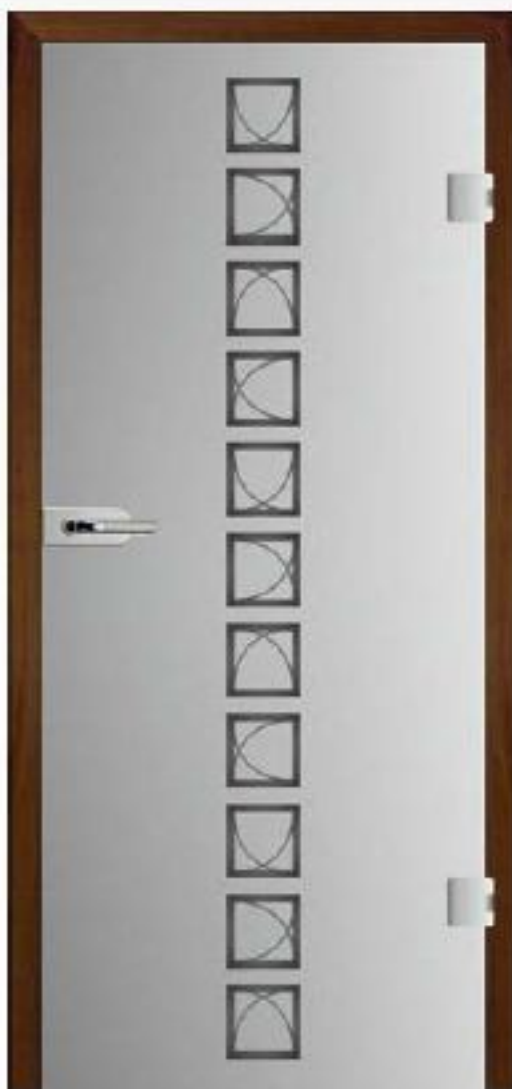

GG M02



GG M03



GG M04



GG M05



GG M06



GG M07



GG M08



GG M09



GG M10



GG M11



GG M12



GG M13



GG M14



GG M15



GG M16



GG M17



GG M18



GG M19



GG M20



GG M21



GG M22



GG M23



GG M24



AMERA 2000/27 WeißBlack



AMERA 2000/7 Weißlack





AMERA 2000/6 Ahorn
Glas-Design 1c



AMERA 4000/5 Buche
Glas-Design 16.1 rot



AMERA 4000/1 Ahorn
Glas-Design 17.2 orange, Glasleisten
in Edelstahloptik



AMERA 2000/25 Ahorn





Riva RIL1 Weißlack
Glas-Design 16.1 rot



Riva RIL5 Weißlack
Glas-Design 17.2 orange



Riva RIL6 Weißlack
Glas-Design 7.2



Riva RIL 1/2 Weißlack
Glas-Design 7.2



Riva RI2 Weißlack



Riva RI3 Weißlack



Riva RI4 Weißlack



Riva RI5 Weißlack



Riva RI6 Weißlack



Riva RI7 Weißlack



Riva RI8 Weißlack



Riva RI9 Weißlack



RIVA RIL1 Weißlack, Glas-Design 18.0



COMO CK1 Weißlack



COMO CKL 1/3 Weißlack
Glas: Float



COMO C2 Weißlack



COMO CL2 Weißlack
Glas: Float



COMO CL2 Weißlack
Glas: Float
Sprossenrahmen SP5



COMO CK2 Weißlack



COMO CKL2 Weißlack
Glas: Float
Sprossenrahmen SPo



COMO CK3 Weißlack



COMO CKL3 Weißlack
Glas: Float
Sprossenrahmen SPo



COMO CK4 Weißlack



COMO CKL4 Weißlack
Glas: Float



COMO CKL4-2 Weißlack
Glas: Float
Sprossenrahmen SP5-2



NEAPEL NL4/2 WeiBlack
Glas: Float



NEAPEL N1 Weißlack



NEAPEL NL1 Weißlack
Glas: Float
Lichtausschnitt SP1



NEAPEL NL1 Weißlack
Glas: Float
Lichtausschnitt SP4



NEAPEL N2 Weißlack



NEAPEL NL2 Weißlack
Glas: Float



NEAPEL N4 Weißlack



PARMA PF1 Weißlack



PARMA PFL1 Weißlack
Glas: Float



PARMA PFL1/3 Weißlack
Glas: Float



PARMA PF3 Weißlack



PARMA PF2 Weißlack



PARMA PFL2 Weißlack
Glas: Float



PARMA PFL4/2 Weißlack
Glas: Float





ROM Ganzglas Ahorn
Glas: Parsol Grau

ROM RL1 Ahorn
Glas: Float



ROM R1 Ahorn



ROM RL2 Buche
Glas: Mastercarré



ROM RL3/1 Buche
Glas: Float



ROM R1 Buche



ROM R3 Ahorn



ROM R2 Buche



ROM R2 Eiche



ROM RL2 Eiche, Glas-Design Satinato, mit 6 Felder Sprossenrahmen



ELBA E1 Ahorn



ELBA E1 Buche



ELBA EL1 Ahorn, Glas: Pavè



FLORENZ F1 Ahorn



FLORENZ FL2 Ahorn, Glas: Mastercarré



FLORENZ FL1 Buche, Glas: Parsol Grau



FLORENZ F2 Buche



FLORENZ FL2 Buche, Glas: Masterlens



ERFURT EG2 Ahorn
Glas: Mastercarré



ERFURT EG3 Ahorn
Glas: Altdeutsch K Bronze



ERFURT ES1 Ahorn



ERFURT EG3, Weißlack
Glas: Gothik weiß



ERFURT ES3, Weißlack
Glas: Float



ERFURT EG1
Buche



SCHONGAU GERADE, Eiche Lack
Glas: Gothik weiß





SCHONGAU GERADE Ahorn



SCHONGAU SEGMENTBOGEN Buche



SCHONGAU SEGMENTBOGEN Buche
Glas: Altdeutsch K Bronze



SCHONGAU GERADE Esche Natur
Glas: Gothik weiß



SCHONGAU GERADE Eiche Lack



SCHONGAU SEGMENTBOGEN
Eiche Lack
Glas: Float



SYLT ST2 Weißlack



SYLT ST3 Weißlack



SYLT ST4 Weißlack



SYLT STL5 Weißlack
Glas: Trio



SYLT STL4/1 Weißlack
Glas: Satinato



SYLT STL1 Weißlack
Glas: Gothik weiß



SYLT ST1 Weißlack



Normtür LA DA CePal
Pirus Nimba
Glas: Masterline



Normtür DQ CePal Pirus Nimba

Normtür LA DA CePal Pirus Carbo
Glas: Satinato

Normtür DQ CePal Pirus Arena



Normtür DA CePal Pirus Terra



NORMTÜR NT-LA4M-DA, Drehtür 2-flg., CePaL Pirus Arena / Zarge: CePaL Pirus Terra, Glas: Masterlignè



NORMTÜR NT-DA, CePaL Pirus Terra



NORMTÜR NT-DQ, CePaL Pirus Arena



NORMTÜR GANZGLAS, Mastercarré



NORMTÜR NT-LA-DQ, CePaL Nussbaum, Quer
Glas: Mastercarré



NORMTÜR NT-DQ, CePaL Nussbaum, Quer



NORMTÜR NT-LA2, Drehtür 2-flg., Weißlack, Glas: Masterligné



NORMTÖR NT, Weißlack



NORMTÖR NT-LA+SP10, Weißlack
Glas: Float





RIVA RI 1, Weißlack
ohne Schlüsselbohrung



COMO CKL 4/2
Weißlack
Sprossenrahmen SP5/2
ohne Schlüsselbohrung



AURA 210
CePal Ahorn Premium
Verglasung „Linear“
ohne Schlüsselbohrung



Schließblech



TECTUS TE 340/3D



TECTUS TE 340/3D, mit Bombierung



NORMTÜR NT-LA-DQ, Schiebetürbeschlag-SLIDE, 2-flg., CePaL Nussbaum Glas: Masterlignè



AURA Ganzglas, Schiebetürbeschlag SLIDE, 2-flg., Design 7.2



AURA 530, Schiebetürbeschlag-ST YLE, 1-flg., Nussbaum
Glas: Design 17.3-orange

AURA Ganzglas, Schiebetürbeschlag-ST YLE, 2-flg.,
Design 17.3-orange



ROM R 1, Schiebetürbeschlag-BAS IC, 1-flg., Eiche Massiv

ROM RL 1, Schiebetürbeschlag-BAS IC, 2-flg., Eiche Massiv
Glas: Parsol Grau



Schiebetürbeschlag-BASIC
Die gehobene Klasse, unser
BASIC-Schiebetürbeschlag
für Holz- und Glastüren.
Öffnen Sie Türen auf klassische Art.



Schiebetürbeschlag-STYLE
Ein Dialog von hochwertigem Edelstahl,
Glas und Holz. Ein starkes Stück Design für
Holz- und Ganzglastüren in moderner Innenarchitektur.

Schiebetürbeschlag-SLIDE
 Das raffinierte und praktische
 Schiebetürsystem in Aluminium für
 Holz- und Ganzglastüren. Moderne
 Glasschiebetüren für strahlende
 Momente.



Schiენenausführung für eine
 Schiebetür mit Lichtausschnitt



Lautloses Gleiten mit minimaler
 Fuge



Sehr stabile Wandbefestigung,
 Funktionselemente verdeckt in der
 Laufschiene.





NORMTÜR
Eckige Kante

NORMZARGE E1
Bekleidung eckig
(55 und 75 mm)
Futterplatte eckig

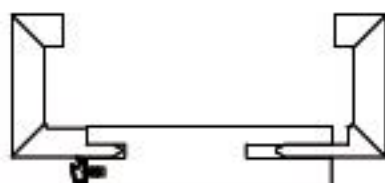

NORMTÜR STUMPF
Eckige Kante

NORMZARGE SE1
Bekleidung eckig
(55 und 75 mm)
Futterplatte eckig

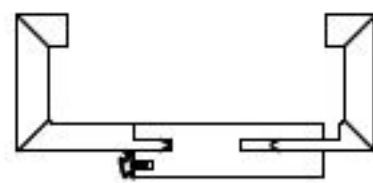

NORMTÜR
Runde Kante

NORMZARGE R1
Bekleidung rund
(60 mm)
Futterplatte rund



NORMTÜR
Runde Kante

NORMZARGE P1
Bekleidung profiliert
(75 mm)
Futterplatte rund



NORMTÜR
Runde Kante

NORMZARGE B1
Bekleidung bombiert
(75 mm) auch in stumpf
Futterplatte rund

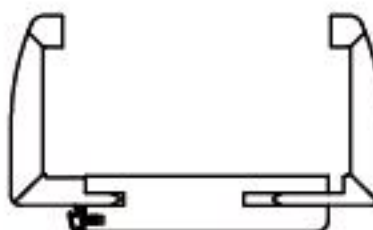



CePaL - die intelligente Oberfläche

Wo es hart auf hart geht, müssen Türen eine Menge einstecken, ohne dass man es ihnen gleich ansieht. Ob in der privaten Mietwohnung oder im gewerblichen Bereich – Sie können sicher sein, dass auf CePaL auch die härteste Beanspruchung kaum Spuren hinterlässt. Schließlich sind die neuen CePaL-Oberflächen nicht nur erstaunlich kratz-, stoß- und abriebfest, sondern auch absolut schmutzunempfindlich und beständig gegen haushaltsübliche Reinigungsmittel. Unglaublich.



kratz- und abriebfest

stossfest

hitzebeständig

Reinigungsmittel
resistent

beständig gegen
Zigaretteglut

pflegeleicht



Furniere

Sie sind das Beste, was Liebhabern natürlicher Materialien passieren kann. 8 Edelholzfurniere von Eiche bis Ahorn, von Buche bis Esche, von Weißeiche bis Mahagoni und anderen beliebten Hölzern zeigen lebendigen Charakter bis in die feinste Maserung. Die sorgfältige Auswahl und die meisterhafte Verarbeitung garantieren auf Tür und Futter ein ausgewogenes Oberflächenbild, die dezente Lackierung veredelt mit individueller Note und sorgt für lange Haltbarkeit und leichte Pflege. Natürlich.



Dekorfolien

Sie sind die Universaltalente für unterschiedlichste Einsatzbereiche: Preiswert, praktisch, pflegeleicht zeigen sie sich überall von ihren besten Seiten und überzeugen mit ganz natürlich wirkenden Holzdekors. Die Auswahl umfasst die fünf wichtigsten Oberflächenvarianten: von Ahorn und Eiche über Buche und Weißlack bis Esche weiß deckend.



Lack

Makellose Lackierungen sind einfach faszinierend. Mit hochwertigen, umweltschonenden UV-härtenden Acryllacken, modernen Walz- und Spritzverfahren und permanenter Qualitätskontrolle sorgen wir dafür, dass **teuto**-Türen auch auf Jahre hinaus nichts von dieser Faszination verlieren. So sind unsere seidenmatten Weißlacktüren überall dort zu Hause, wo klassisches Türdesign und zeitgemäßer Pflegekomfort gefragt sind.

CePal



CePal Pinus Nimba DA



CePal Pinus Nimba DQ



CePal Pinus Carbo DA



CePal Pinus Carbo DQ



CePal Pinus Arena DA



CePal Pinus Arena DQ



CePal Pinus Terra DA



CePal Pinus Terra DQ



CePal Ahorn Premium



CePal Ahorn Exklusiv



CePal Nussbaum DA



CePal Nussbaum DQ



CePal Buche Exklusiv



CePal Eiche Premium



CePal Erle



CePal Wildbirke



CePal Weißlack



CePal Weiß



CePal Esche Weiß



CePal Weiß Struktur Premium



CePal Grau

Furnier



Ahorn



Limba



Weißleiche Natur



Buche



Nussbaum



Eiche hell



Macoré



Sapelli Mahagoni

Dekor



Dekor Esche Weiß



Dekor Ahorn Exklusiv



Dekor Buche Exklusiv



Dekor Eiche Premium



Dekor Weiß

Lack

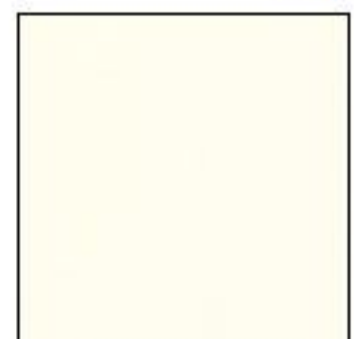

Weißlack



Altdeutsch klar



Barock weiß



Chinchilla



Delta weiß



Eisblume



Float klar



Float satin



Gothik weiß



Madeira weiß



Mastercarre



Masterlens



Masterligne



Masterpoint



Parsol Bronze



Parsol grau



Parsol grün



Pave



Silvit 178



Silvit 178 bronze



Uadi



Seidenmatt positiv



Linux



Linear



Line



Design 1a



Design 1c



Seidenmatt negativ

Normtür
Mittellage
„Röhrenspan“

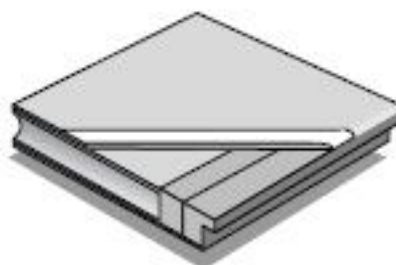
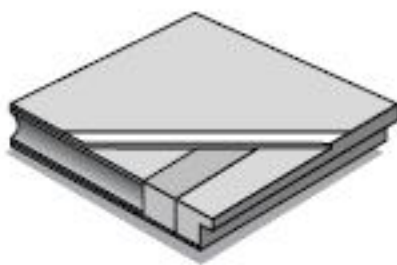

Normtür
mit Rundkante
Mittellage „Röhren-
span“

Normtür
Mittellage
„Wabe“

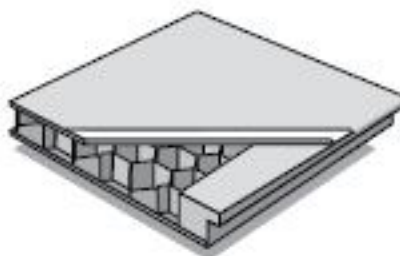
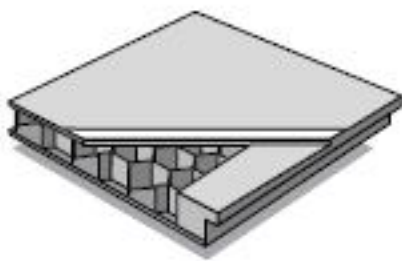

Normtür
mit Rundkante
Mittellage
„Wabe“

Normtür
Mittellage
„Röhrenspansteg“

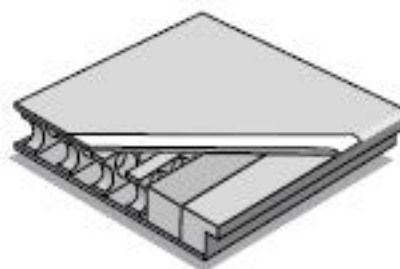
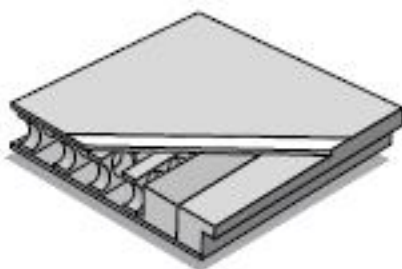

Normtür
mit Rundkante
Mittellage
„Röhrenspansteg“

Normtür
Mittellage
„Lichtausschnitt“

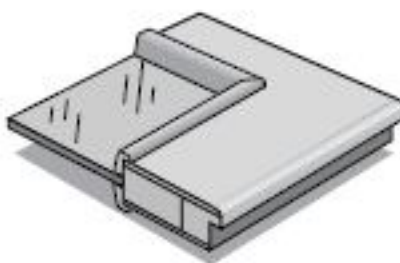
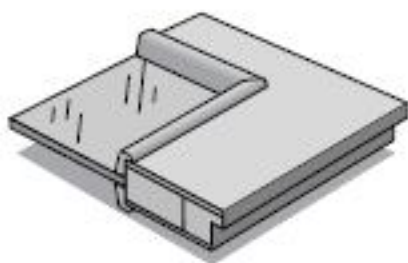

Normtür
mit Rundkante
Mittellage
„Lichtausschnitt“

Normtür
Mittellage
„Vollspan 1-lagig“

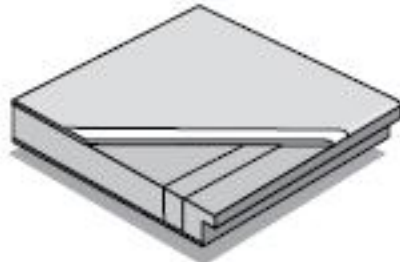
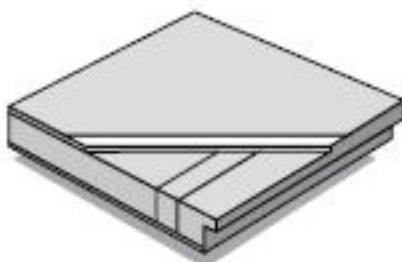

Normtür
mit Rundkante
Mittellage
„Vollspan 1-lagig“

Schlösser



Buntbarschloss



Profilzylinderschloss



Schloss für Badtüren

Dichtung

absenkbare
Bodenabschlussdichtung

Bänder

Badkombination
V 0020/V 3400 WF
für HolzzargeBadkombination
V 0026 WF/V 4400 WF
für HolzzargeBadkombination
V 0026 WF/V 8000 WF
für Stahlzarge

Die im Plattenbau vorhandenen geringen Durchgangsmaße würden sich beim Einbau einer Standardzarge um weitere 6 cm bis 8 cm verkleinern. Schiefe Durchgänge erschweren zusätzlich die Montage einer Standardzarge und schließen sie teilweise sogar aus. Die unterschiedlichen Öffnungsmaße sind mit Standardzargen nicht kombinierbar und erfordern somit immer eine Maßanfertigung. Hinzu kommt häufig eine weitere Problematik: Standardzargen decken häufig die Falzöffnung nicht komplett ab. Es ergibt sich eine unschöne Optik.



vor der Sanierung

Renovierung mit herkömmlichen Standardzargen

Das lichte Durchgangsmaß verringert sich um 6 cm - 8 cm. Der Zugang zur Wohnung wird sehr stark verkleinert. Bei einem Umzug können z. B. neue Möbel oder eine neue Waschmaschine kaum in die Wohnung gelangen. Beschädigungen an der Zarge lassen sich nicht vermeiden.

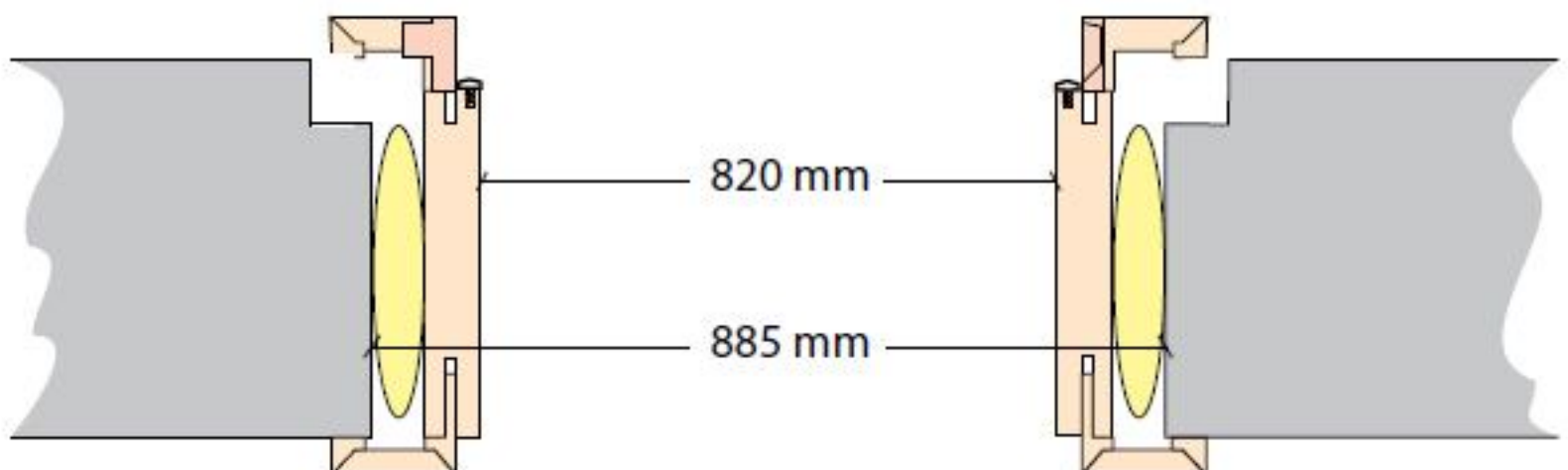



ITB-2 Renovierungszarge

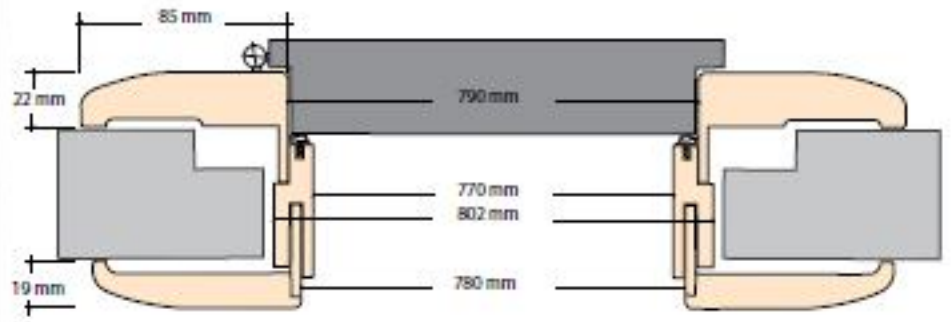

Blendrahmen

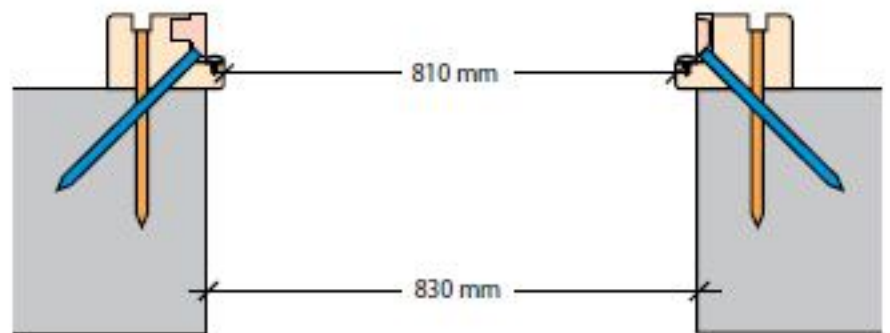

Blendrahmen mit Gegenbekleidung

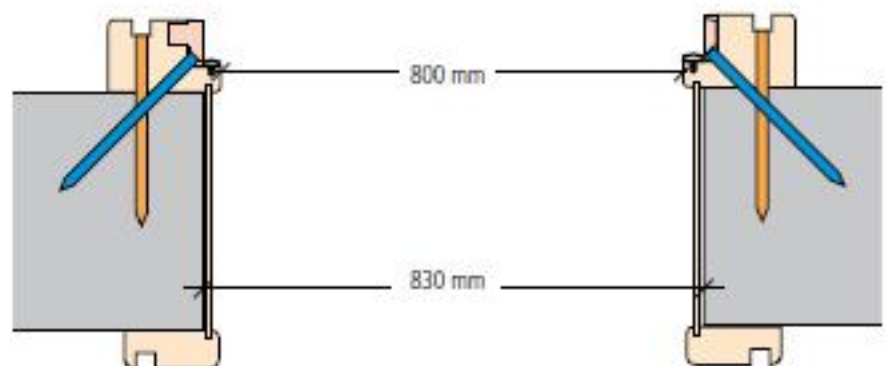

vor der Sanierung



nach der Sanierung



Sanierungsbeispiele



Zargen für Wandstärken von 45 mm bis 330 mm. Optimale Stabilität auch bei dünnen Wänden.
Bemaßung für Türblatbreite 670 mm

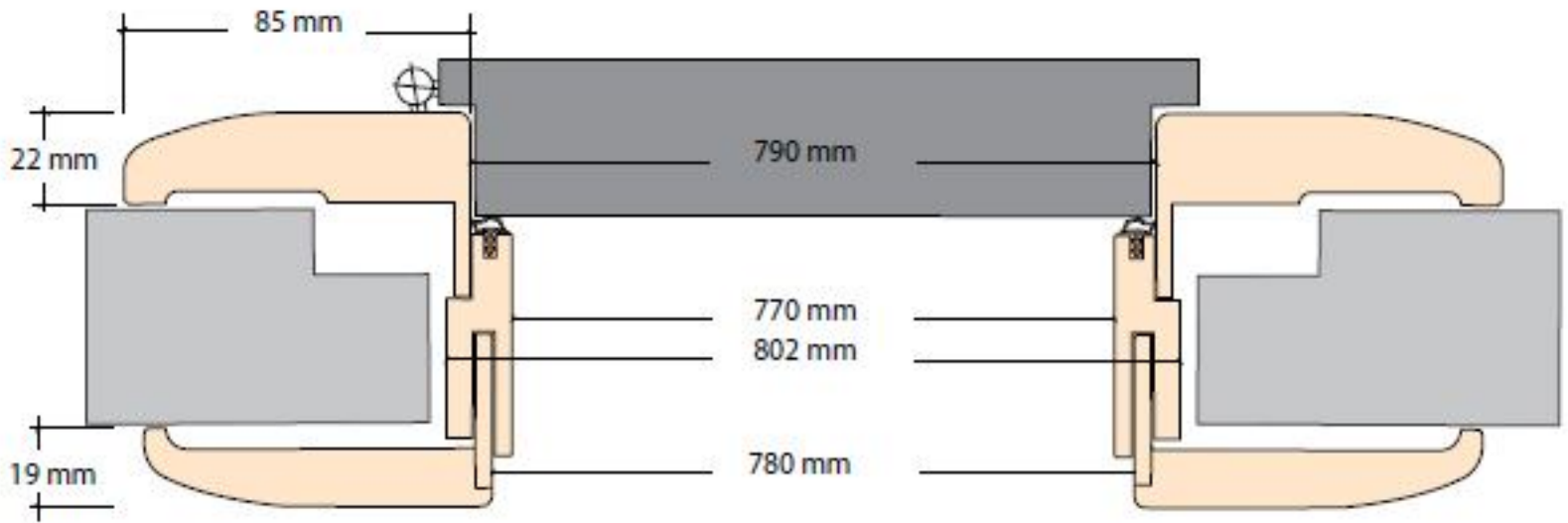

Mehr Durchgang mit Renovierzargen

Mit den Elementen sparen Sie nicht nur Zeit und Geld, vor allem sparen Sie Platz. Denn durch die Systemtüren wird das Durchgangsmaß Ihrer Wohnungstüren nur geringfügig verringert. Durch die individuelle Anpassung ist das Entfernen der vorhandenen Blechzarge nicht erforderlich. Eine saubere und schnelle Montage, ohne Hammer und Meißel. Perfekt bis ins kleinste Detail werden die Zargen gefertigt. Ob saubere Gehrungen oder stabile Bänder, alle Komponenten sind aufeinander abgestimmt. Die Türen sind mit einer stabilen Röhrenspanplatte ausgestattet und in den Dekoren Buche, Eiche sowie in den kratzfesten CPL Oberflächen Buche, Eiche und Weißlack erhältlich. Wir wissen was Sie wollen!

ITB-2 als Schiebetürelement

Schiebetürelement vor der Wand laufend mit Laufschiene und Verkleidungskasten.
Auf Wunsch auch mit Anlaufpfosten lieferbar.



lieferbare Oberflächen für ITB-2



Dekor Buche

Dekor Eiche hell

CePal Buche

CePal Eiche
Premium

CePal Weiß

Dekor Weiß

Weißlack

Fertigblendrahmen

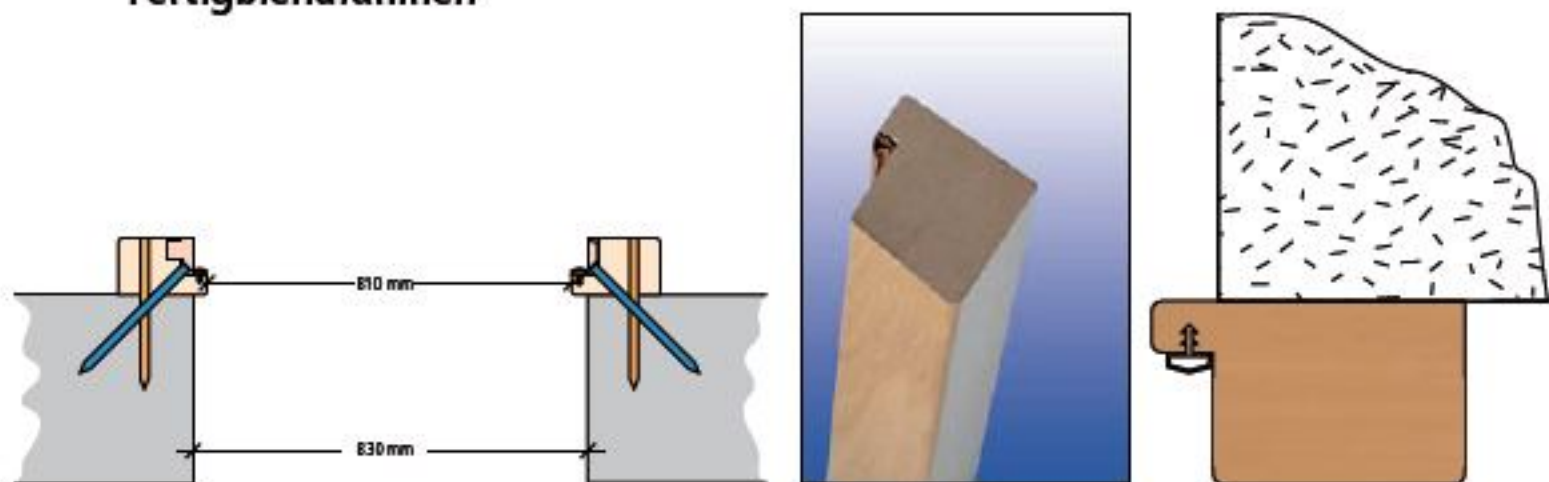

Lieferbare Oberflächen für Blendrahmen und Blockrahmen.



Fertigblockrahmen

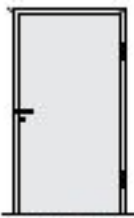
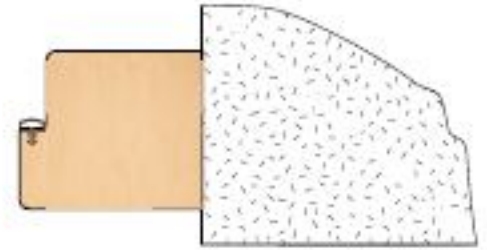

Z-Typ 1

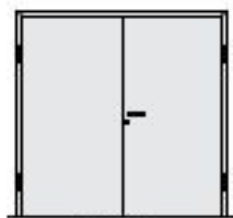

Z-Typ 3



Z-Typ 4



Z-Typ 5



Z-Typ 6

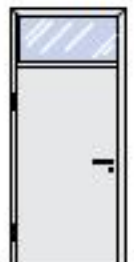

Z-Typ 10



Z-Typ 11



Z-Typ 13

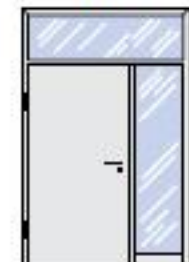

Z-Typ 14



Z-Typ 15



Z-Typ 16



Z-Typ 7

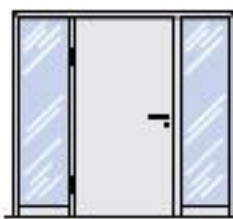

Z-Typ 8

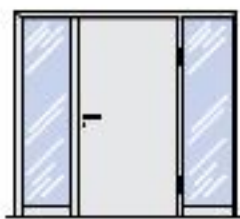

Z-Typ 9



Z-Typ 17



Z-Typ 18

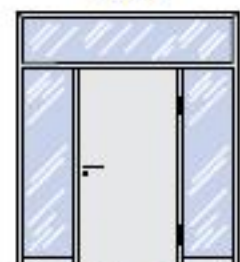

Z-Typ 19



Blendrahmen ohne Montagenut

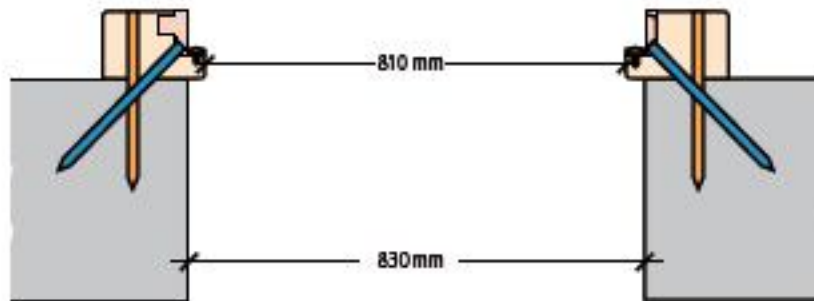

Blendrahmen mit Montagenut und Kedernleiste

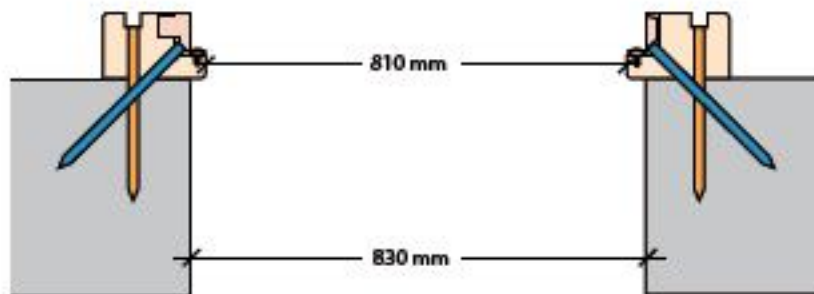

Blendrahmen mit Gegenbekleidung ohne Montagenut

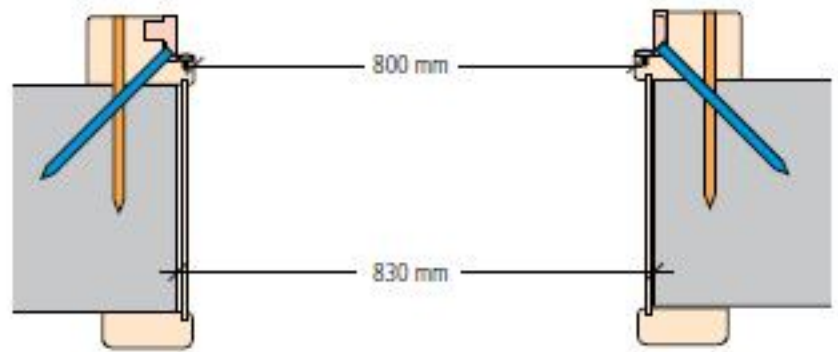

Blendrahmenezarge mit Gegenbekleidung und Montagenut

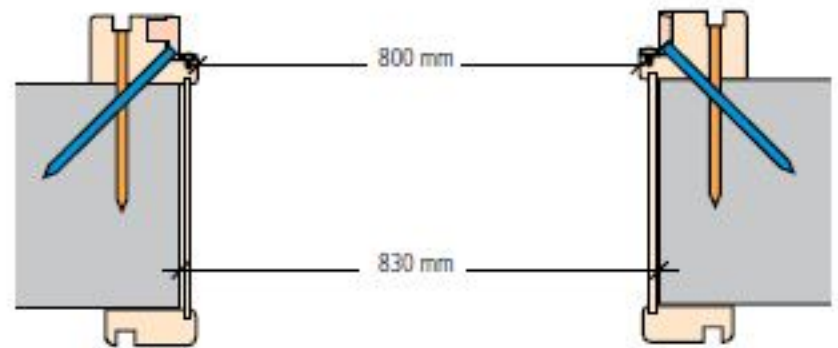

Lieferbare Oberflächen für WK-2 Blendrahmen mit Gegenbekleidung.



Weißlack



Dekor Buche exkl.



Dekor Eiche Prem.



CePal Buche exkl.



CePal Eiche Prem.

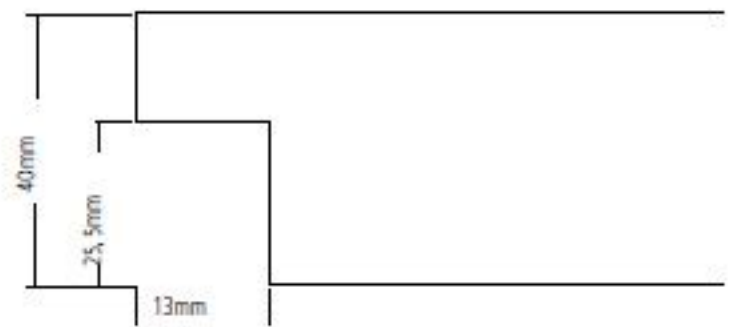
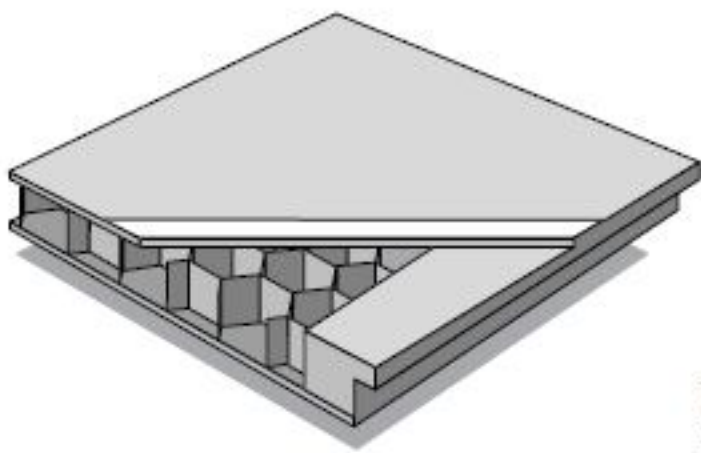

Wabe

nur in Dekor Buche und Dekor Eiche hell lieferbar

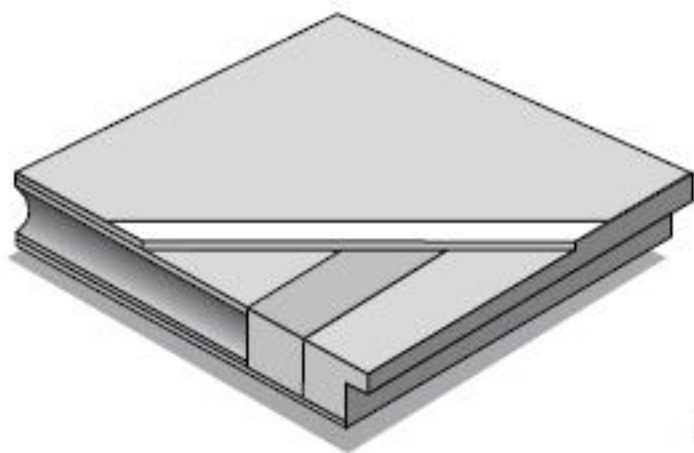

Röhrenspan

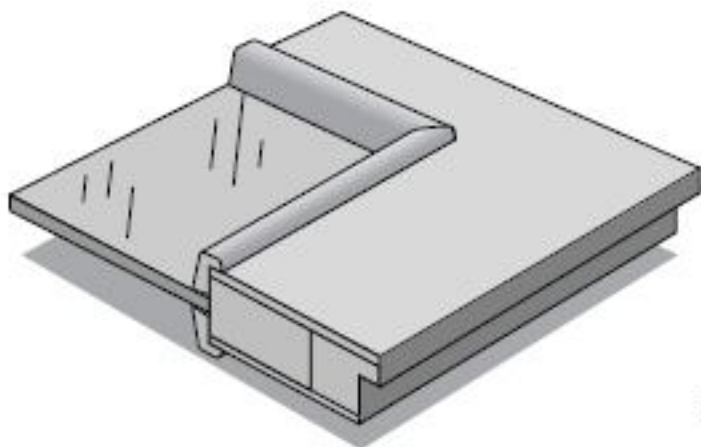

Lichtausschnitt

						
Ahorn	Buche	Eiche lack.	Limba	Limba streichf.	Weißlack	
						
Dekor Ahorn Exklusiv	Dekor Buche Exklusiv	Dekor Eiche Premium	Dekor Esche weiß			
						
CePal Ahorn Exklusiv	CePal Buche Exklusiv	CePal Esche weiß	CePal weiß	CePal Pirus Nimba	CePal Pirus Carbo	CePal Nussbaum
						
CePal Eiche Premium	CePal Ahorn Premium	CePal Grau Premium	CePal weiß Struktur Premium	CePal Pirus Arena	CePal Pirus Terra	CePal Erle
						
					CePal Weißlack	CePal Wildbirke



Schlossseite für Renovierungs- und Blendrahmenezargen

Geprüfte Sicherheit : Auf der Schlossseite werden Sicherheitselemente nach DIN 18251 verwendet.
Die zusätzlichen Verankerungen der Aufnahmeelemente im 45° und 90° Winkel erhöhen die Sicherheit.

